

#700220, #700222 & #700223

INTERLOCKING PEGBOARD COUNTER UNITS W/ REVOLVING BASE

- 1** FOR ITEM #700220 Place pegboard tower onto revolving base slightly angled. Then twist the pegboard tower to lock into place on revolving base.
- 2** FOR ITEMS #700222 & #700223 Place pegboard tower w/ top cap onto other pegboard tower slightly angled. Then twist to lock into place. Repeat till all pegboard towers are attached. Then place pegboard tower onto revolving base and twist clockwise to lock into place.

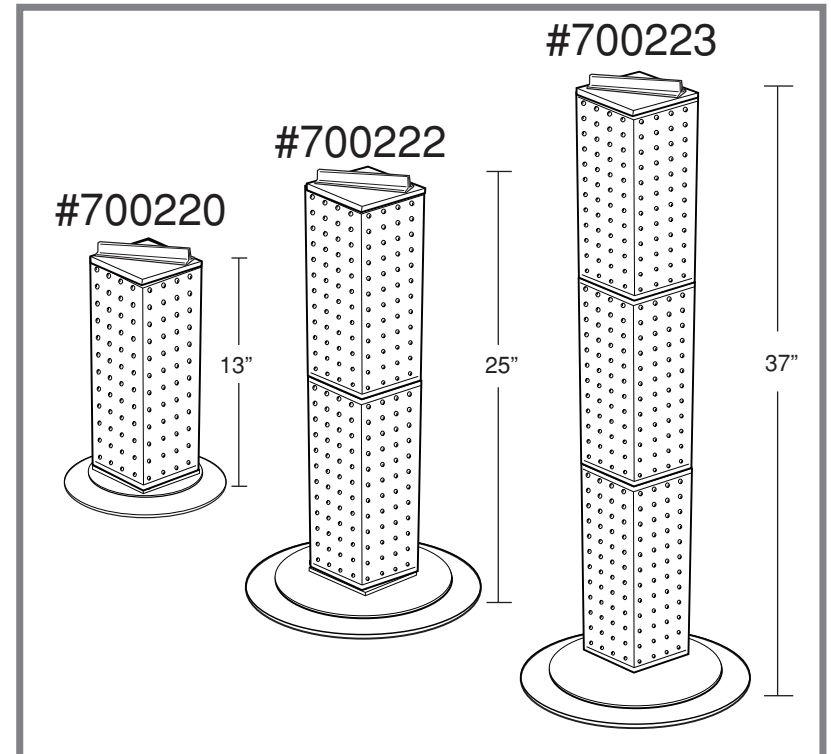
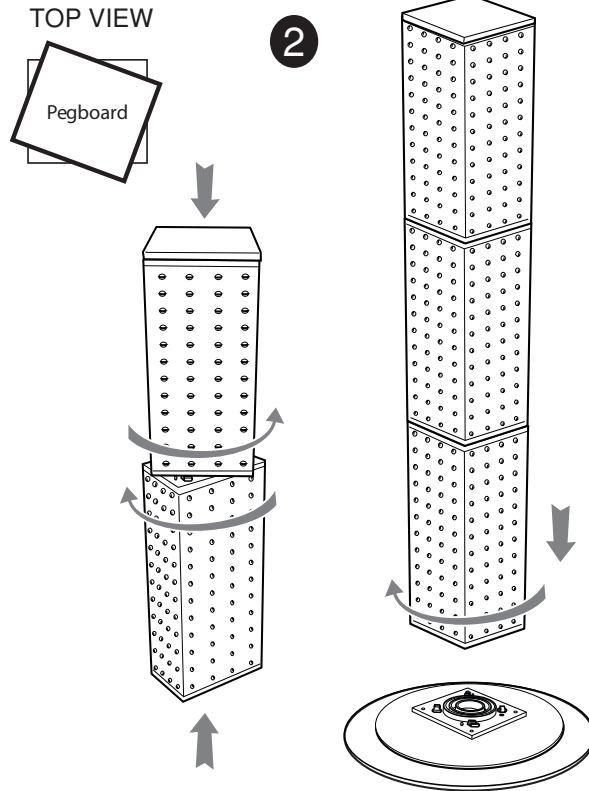
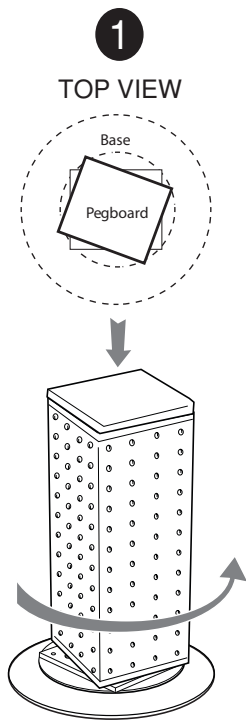

T-STRIP FOR SIGN HOLDER - INCLUDED

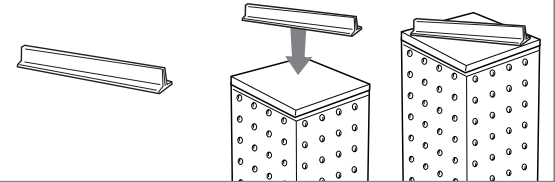

Remove paper strip on double sided tape before connecting to top of pegboard tower cap

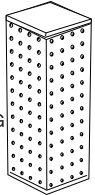
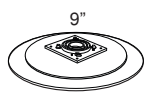

#700220

<p>1 pc. 4" X 12" INTERLOCKING PEGBOARD TOWER WITH TOP CAP</p> 	<p>1 pc. 9" PLASTIC REVOLVING BASE</p> 
---	---

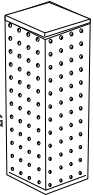
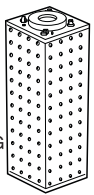
#700222

<p>1 pc. 4" X 12" INTERLOCKING PEGBOARD TOWER WITH TOP CAP</p> 	<p>1 pc. 4" X 12" INTERLOCKING PEGBOARD TOWER</p> 	<p>1 pc. 14.5" PLASTIC REVOLVING BASE</p> 
---	---	--

#700223

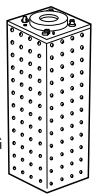
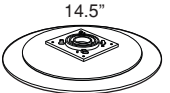
<p>1 pc. 4" X 12" INTERLOCKING PEGBOARD TOWER WITH TOP CAP</p> 	<p>2 pcs. 4" X 12" INTERLOCKING PEGBOARD TOWER</p> 	<p>1 pc. 14.5" PLASTIC REVOLVING BASE</p> 
---	---	--